



**AKO** UK

Valve & Flow Control Technology

# Operating Manual (Original) for Air operated Pinch Valves



**Series VF - VM - VMF - VMP - VMC - VMCE - VT  
Ex-Series VMX - VMPX - VMCX - VFX**

## Contents

1.	<i>SAFETY INSTRUCTIONS</i> .....	3
	Special conditions and safety instructions for use in potentially explosive areas .....	3
2.	<i>USAGE</i> .....	4
2.1	Intended use .....	4
2.2	Improper use .....	4
2.3	Function .....	4
3.	<i>TECHNICAL DESCRIPTION</i> .....	5
3.1	Control .....	5
3.2	Technical data .....	5
3.3	Operating data .....	5
4.	<i>ASSEMBLY</i> .....	5
4.1	Preparation .....	5
4.2	Mechanical connections .....	5
4.3	Connecting the control pressure .....	5
5.	<i>COMMISSIONING</i> .....	6
5.1	Requirements .....	6
5.2	Normal operation .....	6
6.	<i>MAINTENANCE AND REPAIR</i> .....	6
6.1	General specifications .....	6
6.2	Inspection .....	6
6.3	Maintenance intervals .....	6
6.4	Repair work .....	6
7.	<i>MALFUNCTIONS</i> .....	6
8.	<i>STORAGE</i> .....	6
9.	<i>DISPOSAL</i> .....	6
10.	<i>ADDITIONAL DOCUMENTATION</i> .....	6
11.	<i>MAINTENANCE / REPAIR INSTRUCTIONS</i> .....	7
11.1	General principles for fitting the pinch valves .....	7
11.2	General principles for the maintenance/repair of the pinch valves .....	8
11.3	Air operated Pinch Valve series VF, DN 40-80 .....	9
11.4	Air operated Pinch Valve series VF, DN100-300 .....	10
11.5	Air operated Pinch Valve series VMC, DN10-50, type F, FA, G, M, N, R, RA, T, TA .....	11
11.6	Air operated pinch valves series VMC, DN65-80, Type F, FA .....	12
11.7	Air operated pinch valves series VMC, DN65-80, Type G, M, N, R, RA, T, TA, FT .....	13
11.8	Air operated pinch valves series VMC, DN100, Type F, FA .....	14
11.9	Air operated pinch valves series VMC, DN 100, Type G, M, R, RA, T, A .....	15
11.10	Air operated pinch valves series VMC, DN125-150, Type F, FA, R, RA, T, TA .....	16
11.11	Air operated pinch valves series VMP, DN10-50 .....	17
11.12	Air operated pinch valves series VM+VMF, DN10-50 .....	18
11.13	Air operated pinch valves series VT, DN100 .....	19
12.	<i>APPENDIX</i> .....	20
	Possible malfunctions of air-operated pinch valves .....	20

This operating manual ensure safe installation and safe commissioning of the air-operated AKO pinch valves. Please read and follow these safety instructions and observe the operating manual prior to any installation or maintenance.

## 1. Safety Instructions

The installation, maintenance and commissioning must only be performed by qualified personnel or by personnel assigned by the operator. The operating manual with the safety instructions must be to hand at all times for operating and maintenance personnel.



### CAUTION! Danger of crushing

Severe crushing may occur when closing the pinch valve.

- › Do not put your hands or other body parts in the opening.
- › Perform measures that prevent the insertion of fingers or hands into the interior space of the pinch valves.
- › Install appropriate warnings if required.

Severe crushing may occur when closing the pinch valve.

Use dry, oil-free and filtered compressed air as a control medium to avoid corrosion and damage to the pinch valve and sleeve.

Isolate the control pressure and relieve the pinch valve of any pressure immediately in case of failure of or damage to the pinch valve. The control pressure air connection must remain under pressure. Remove the pinch valve only when it is not under pressure.



Contact protection must be provided and marked by the operator if necessary at high temperatures. Any warning signs, such as „Hot surface“ must be affixed to the pinch valve. Heating/insulation against freezing is to be provided at excessively low temperatures.

### Note

Condensation may form in the control medium area between the surrounding area, control medium and operating medium if there are large temperature differences. This can get into the control pressure supply line and must be drained/disposed of in a controlled manner.

The operator must depressurise the pinch valves in case of a fire to ensure that damaged pinch valves cannot explode.

The maximum pressure and temperature specifications on the type plate must be observed and strictly adhered to.

A pressure regulating valve/pressure limiter is to be installed in the control pressure supply line and set to the control pressure to be calculated.

### Optimum control pressure (Calculation Example)

Operating pressure (pumping pressure)	3.0 bar
+ Differential pressure (see type plate)	2.5 bar
= Optimum control pressure to be set	5.5 bar



### Special conditions and safety instructions for use in potentially explosive areas



The installation, maintenance and commissioning must be monitored and inspected by a person qualified in explosion protection.

The categories indicated on the type plate for the area at risk of explosion (interior area/pumping area) as well as for the zone (external area/surrounding area) are decisive for the use of the pinch valve.

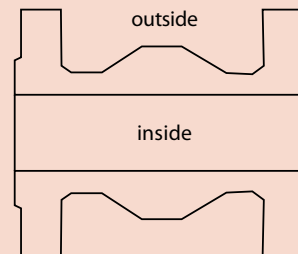

For interior areas at risk of explosion (Ex) 0, 1, 2 and 20, 21 and 22 plus external areas at risk of explosion (Ex) 1, 2 and 21, 22:

Series	VMX, VMPX, VMCX,
Sleeve type	Mxxx.xxLF
Connection type (material)	50 (st. steel), 73 (POM)
Body type (material)	50 (st. steel), 73 (POM)

The following pinch valves are suitable for interior areas at risk of explosion (Ex) 1, 2 and 21, 22 plus external areas at risk of explosion (Ex) 1, 2 and 21, 22:

Series	VFX, VMCX
Sleeve type	Mxxx.xxLF
Connection type (material)	50 (st. steel), 31 (aluminum with steel)- 35 (aluminum with st. steel)
Body type (material)	30 (aluminum)

All electrical equipment fitted, such as solenoid valves, pressures switches and air vents, must be suitable for operation in areas at risk of explosion (Ex) and have their own manufacturer's certificate or conformity assessment for use in areas at risk of explosion (Ex).

Use only materials as a control medium that cannot lead to a risk of explosion. The operator must ensure that any air operated/plastic hoses used are electrostatically conductive.



The pinch valves must be adequately connected to a conductive, earthed pipe. The pinch valve is to be earthed if the pipe is not electrically conductive (at least a 4 mm<sup>2</sup> copper strand when fitted without protection). A fixing screw with marking is located on the pinch valve for connecting the earthing.

The potential equalisation (earthing) between the pipe and pinch valve must be checked with a suitable measuring device after it is fitted in the pipe.

The layer thickness of any coating must not be greater than 200 µm.

The temperature of the pumping medium may increase through friction when operating in the pumping area. The temperature must not be higher than 80% of the flashpoint of the pumping medium. Otherwise the maximum temperature of the pinch valve applies.

It must be impossible for corrosion particles (e.g. rust) in the pumping medium to come into contact with the aluminium of the pinch valve.

The occurrence of ignition sources as a result of ionising radiation, X-rays, cathodic corrosion protection, stray currents, adiabatic compression, flames and hot gases, electromagnetic waves, lightning, sparks due to friction and impact must be safely prevented by the operator.

As the sleeve is a wear part, the control medium may get into the pumping area due to a leak. If the pumping medium is a liquid fuel and mixes with air, this may create a potentially explosive atmosphere in the pumping area. Conversely, the pumping medium may penetrate into the control pressure medium and create a potentially explosive atmosphere there.

Pinch valves with a protective coating (e.g. paint) made of non-conductive material must be fitted with contact discs/tooth lock washers (e.g. DIN6797A) in the plant. Unstable gases must not be used as a pumping medium.

Pinch valves and accessories must be considered individually for their respective use in areas at risk of explosion (Ex) and suitable for use there. Therefore, they cannot be supplied by AKO as an assembled unit. Accessories are not put together as an assembly as defined by the ATEX Directive 3.7.5. The operator must determine the suitability of accessories supplied for use in areas at risk of explosion (Ex).

Subsequent changes to the pinch valve require renewed explosion protection testing. AKO's explosion protection certificate will lapse.

## 2. Usage

The pinch valves were evaluated in accordance with the requirements of the Pressure Equipment Directive (PED) and the machine directive RL 2006/42/EG 97/23/EC. Air operated pinch valves are not covered by the scope of ATEX 94/9/EC.

### 2.1 Intended use

The pinch valve is used to isolate or interrupt the material flow of fluids with solid and liquid components or dusts in pipes and hoses.

### 2.2 Improper use

- Non-compliance with the operating manual including the safety instructions.
- Operating the pinch valve for a purpose other than its intended use.
- Unauthorised or untrained personnel operating the pinch valve.
- Installing non-original spare parts.
- Violating the applicable standards and laws.

AKO does not accept liability for damage resulting from failure to observe the specifications, safety instructions and warnings in the operating manual or the modification of the pinch valve.

### 2.3 Function

A flexible elastomer hose (sleeve) is compressed by increasing the pressure in the pinch valve body. This creates a lip-shaped closing pattern (Fig. II). Powders and grains up to a certain size are enclosed by the elastic sleeve. This ensures the pinch valve tightness. The sleeve is opened again when the control pressure is removed and by the restoring force of the sleeve.(Fig. I).

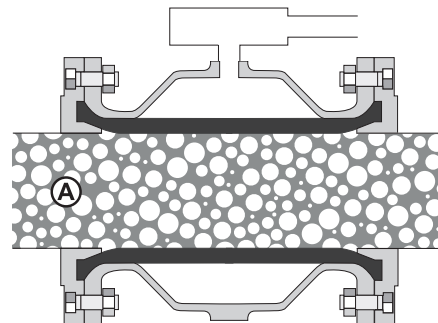

Fig. I

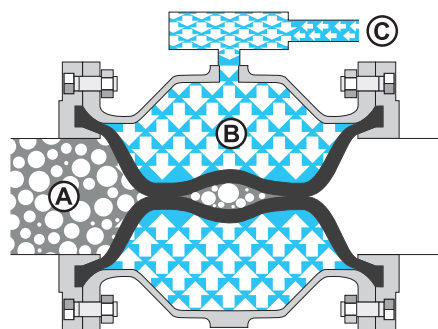

Fig. II

- (A) Operating pressure (pumping pressure)  
 (B) + Differential pressure (see type plate)  
 (C) = Optimum control pressure to be set

## 3. Technical description

### 3.1 Control

The pinch valve should be actuated by a control valve (e.g. 3/2-way solenoid valve) fitted directly to the control pressure connection. Any control pressure supply line between the control valve and pinch valve should be as short as possible. We recommend the following cross-section in each case:

- DN10-DN25 = 4 nominal size
- DN32-DN150 = 6 nominal size
- DN200 = 9 nominal size
- DN250-DN300 = 13 nominal size

We recommend installing a quick exhaust valve directly on the control connection so that the sleeve can be opened quicker (control medium: air). A pressure switch to monitor the control pressure can also be fitted (OPEN/CLOSED position). Defects in the sleeve can be detected in good time and replaced in a targeted manner in most cases using this pressure switch. Pressure compensation with the product flow must be provided on the control medium side if the pinch valve is operated in a vacuum process below 100 mbar.

*Please refer to the "Pinch valve control examples" technical information sheet at [www.pinch-valve.com](http://www.pinch-valve.com) for control recommendations.*

### 3.2 Technical data

Control medium	Compressed air, neutral gases, water
Installation position	Any (see section. 4.3)
Flow direction	Any
Medium	Gaseous, liquid, solids

### 3.3 Operating data

Operating pressure (A)	Can be read off the type plate
Control pressure (C)	See calculation example: safety instructions and type plate

Differential pressure (B) Can be read off the type plate

Temperature range Can be read off the type plate

Please contact AKO immediately if the type plate is missing.

*The technical data of the individual pinch valves can be found in the respective data sheet.*

## 4. Assembly

### 4.1 Preparation

A function test must always be performed before fitting the pinch valve.

### 4.2 Mechanical connections

Connect the factory pre-assembled pinch valve to the plant connections.

- › Avoid stresses and impact from external forces and torques
- › Vibrations in the plant can cause the destruction of the pinch valve or the connections. There must be at least twice the face-to-face length of the pinch valve between an elbow and the pinch valve as a shorter pipe length will lead to premature wear on the sleeve and flange because of the turbulence generated.
- › Appropriate supports are to be provided depending on the respective weight of the pinch valve and when several pinch valves are fitted sequentially.

**Internal thread connection according to DIN EN ISO 228 (G) or ANSI/ASME B1.20.1 (NPT):** Use a suitable sealant for the threaded connection seal, such as PTFE sealing strip.

- Pinch valves series VMP/VMC: Install by hand or with a strap spanner.
- Pinch valves series VM/VMF: Secure the connection thread on the pinch valve against rotation with a suitable open-end wrench to prevent the sleeve turning when it is being installed.

**Flange connection according to DIN EN 1092-1 PN 10/16 or ANSI B 16.5/150 lbs:** Use suitable, standard flange seals to seal the flange connections. An additional flange seal is not needed when pinch valves have a flange sleeve. Make sure that the flange surfaces are clean and undamaged. Use standard flange screws. Tighten the screws evenly and crossways, initially 50% and then 80%. Re-tighten the screws once or several times during commissioning if necessary to ensure the sealing effect.

**Other connections (e.g. threaded spigot, weld-on ends, tri-clamp, semi-silo trailer):** Connect all other connections in accordance with their intended purpose and according to general engineering practice.

### 4.3 Connecting the control pressure

Connect the pinch valve to the control pressure supply line. The control pressure supply line is to be installed in the pipe in such a way that any condensation can run out of the pinch valve. A water separator should always be provided upstream of the pinch valve. Adjust the defined control pressure on the pressure regulating valve/pressure limiter.

#### Water as a control medium

Control valves must be suitable for water and have a sufficiently large cross-section. This influences the closing/opening time of the pinch valve and therefore also the service life of the sleeve.



## 5. Commissioning

### 5.1 Requirements

Only put the pinch valve into operation when the following measures have been taken:

- Pinch valve must be securely attached with the designated connections.
- Pressure regulating valve/pressure limiter must be installed and adjusted in the control pressure supply line.
- Any safety devices required must be in place and fully functional.
- The operator must demonstrate that the pumping medium is compatible with the pinch valve materials.

### 5.2 Normal operation

Use the pinch valve exclusively for its designated purpose. Follow the safety instructions.

Safety and protective devices or warning signs fitted to the pinch valve must not be removed. The pinch valve has no control pressure in an open position. It closes only when the optimum control pressure is applied.

The pinch valve must be relieved of any pressure immediately and taken out of operation immediately in case of damage.

Check the pinch valve sleeve if the level drops below or exceeds the permissible operating/control pressure or the permissible operating temperature.

## 6. Maintenance and Repair

### 6.1 General specifications

Carry out maintenance and repair work only when the control pressure has been released. Operations must cease in the pumping area for the duration of the work. The control pressure supply line must be disconnected from the pinch valve. The power supply to the attachments (e.g. on the pressure switch) must be disconnected.

It is important to ensure that there is not potentially explosive atmosphere.

Precautions must be taken (e.g. personal protective equipment) if dangerous substances may escape whilst carrying out maintenance work on the pinch valve. *Please refer to the respective safety data sheet for specifications, safety instructions and warnings related to the pumping medium.*

### 6.2 Inspection

- The service life of the sleeve is dependent on the control pressure, quality of the sleeve, operating temperatures, pumping medium, nominal size, load change duration/frequency, control and its components.
- Check the proper function of the pinch valve once per

month. Depending on the operating conditions, a functional check in shorter intervals may be required.

- Determine the inspection intervals depending on the operating conditions and the frequency of the operation.
- Check the sleeve at regular intervals for wear and damage.
- Check that the pressure switch is set correctly and that the connection and joints on the pinch valve are fitted correctly and sealed.

### 6.3 Maintenance intervals

The operator is responsible for the creation of a maintenance plan that includes the maintenance intervals (see information on the service life of the sleeves in section 6.2).

- Create a maintenance plan based on the information gathered in the inspections.

### 6.4 Repair work

Damaged sleeves, connections and joints as well as protection and safety settings must be repaired immediately or replaced with original spare parts.

The pinch valve must not be used until the proper function of the plant has been fully restored.

## 7. Malfunctions

A list with possible malfunctions, causes and their solution can be found in appendix..

## 8. Storage

Store the pinch valve and replacement sleeves at room in a dry and dust-free environment, protected from UV radiation. The technical properties of the sleeves deteriorate with an increased storage time.

## 9. Disposal

Pinch valves can be recycled. The environmental guidelines in force at the operator's location are applicable for the disposal.

## 10. Additional Documentation

The following documents are available on the internet at <http://www.pinch-valve.com/downloads/air-operated-pinch-valves.html> or on request.

- Quick instructions (BAK\_pV\_...)
- Data sheets (DB\_pV\_...)
- Technical information sheets (TI\_pV\_...)
- Codification lists (KL\_pV\_...)
- Declarations of conformity (KE\_pV\_...)
- Certificates (HB\_pV\_...)

The required document can be identified based on the part number (see order, delivery note, invoice or type plate). It is coded. Example:

VMC100.03x.50E.50LA  
 ↑                    ↑  
 Series      Connection type

A detailed breakdown can be found in the codification lists (KL\_pV\_...).

# 11. Maintenance / Repair Instructions

## 11.1 General principles for fitting the pinch valves

Structure shown for series  
VF+VT, DN40 to 300

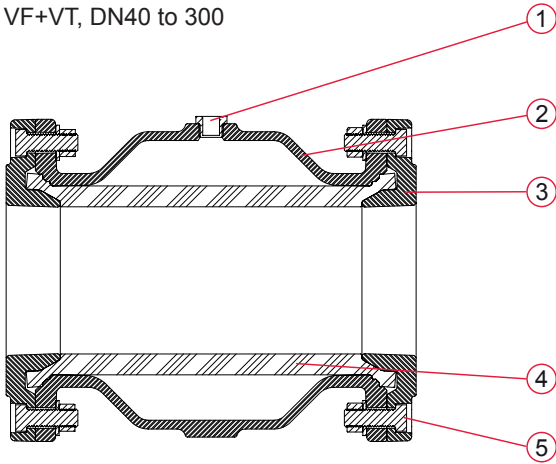

- ① Control air connection
- ② Body
- ③ Flange\*
- ④ Sleeve\*
- ⑤ Screws\*

Structure shown for series  
VMC, DN10 to 50 (F, FA, G, M, N, R, RA, T, TA)

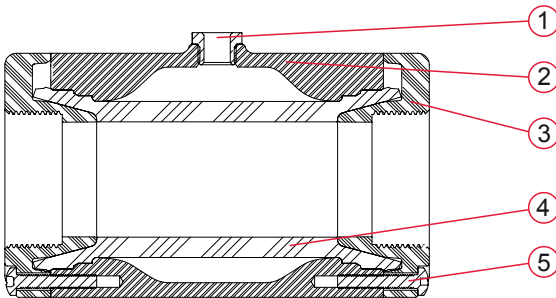

- ① Control air connection
- ② Body
- ③ Socket end cover/  
flange\*
- ④ Sleeve\*
- ⑤ Screws\*

Structure shown for series  
VMC, DN65 to 100 (F, FA, G, M, N, R, RA, T, TA, FT), + VMCE + VT

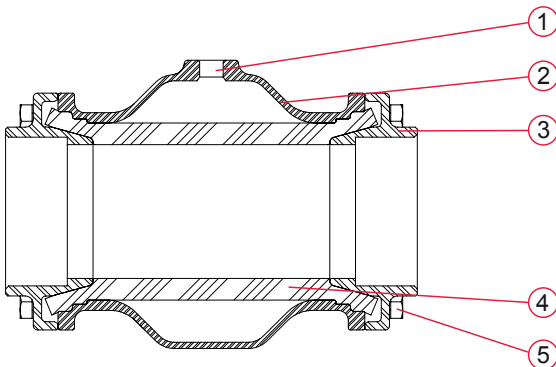

- ① Control air connection
- ② Body
- ③ Socket end cover/  
flange\*
- ④ Sleeve\*
- ⑤ Screws\*

\* Wear parts

Structure shown for series  
 VMC DN125 ro 150 (F, FA, G, M, N, R, RA, T, TA)

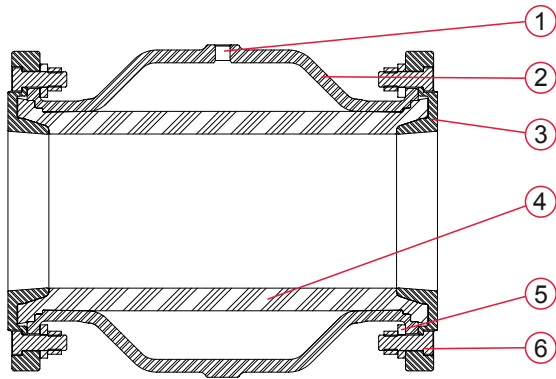

- |                                |                  |
|--------------------------------|------------------|
| ① Control air connection       | ④ Sleeve*        |
| ② Body                         | ⑤ Mounting discs |
| ③ Socket end cover/<br>flange* | ⑥ Screws*        |

Structure shown for series  
 VMP, DN10 to 50

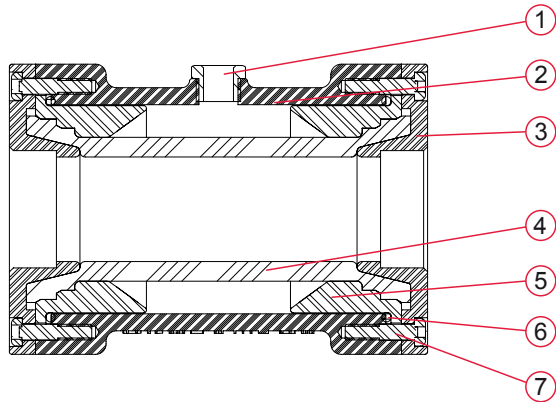

- |                                |                      |
|--------------------------------|----------------------|
| ① Control air connection       | ⑤ Pressure zone ring |
| ② Body                         | ⑥ O-ring body*       |
| ③ Socket end cover/<br>flange* | ⑦ Screws*            |
| ④ Sleeve*                      |                      |

Structure shown for series  
 VM+VMF, DN10 to 50

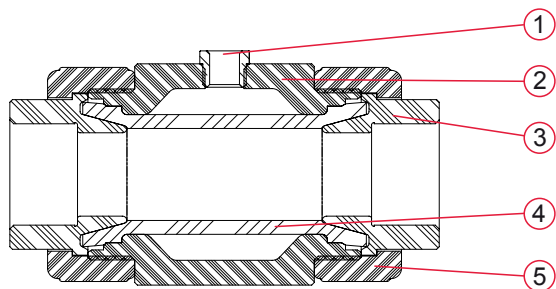

- |                          |                |
|--------------------------|----------------|
| ① Control air connection | ④ Sleeve*      |
| ② Body                   | ⑤ Coupling nut |
| ③ Socket end*            |                |

\* Wear parts

### 11.2 General principles for the maintenance/ repair of the pinch valves

- Use only AKO assembly paste and no adhesive, grease or oil!
- Do not use any sharp or pointed objects during assembly to avoid damage to the sleeve/valve!
- Assembly aids or kits can be ordered.



### 11.3 Air operated Pinch Valve series VF, DN 40-80

**Assembly aid:** AKO assembly paste MP200 or MPL200 for the food sector

#### Dismantling

Place the pinch valve facing upwards and hold it tightly on the body. Loosen the nuts crossways with a spanner (SW19). Then turn the pinch valve and also loosen all screws crossways.

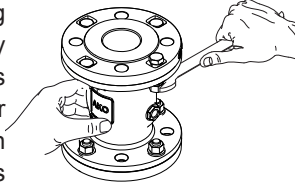

Lift both flanges off the valve unit. Use a slot screwdriver to do this if necessary.

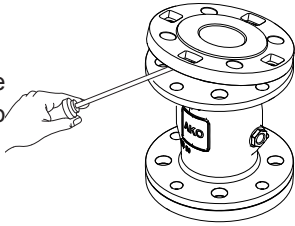

Push or pull the sleeve out of the body. Use a pipe wrench if necessary.

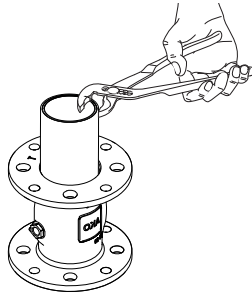

This is made easier by using AKO assembly paste (MP200/MPL200) as lubrication between the sleeve and body.

Clean all individual parts afterwards and check the parts for damage as well as for ageing and porosity. Replace damaged parts.

#### Assembly

Insert the sleeve into the body until it protrudes evenly at both ends.

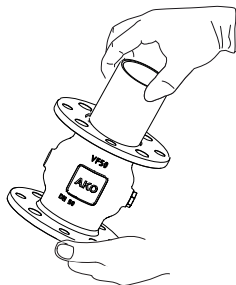

Use a little AKO assembly paste (MP200/MPL200) between the sleeve and body in case of stiffness.

Apply AKO assembly paste (MP200/MPL200) to the inside of both ends of the sleeve and to the cones of the flanges.

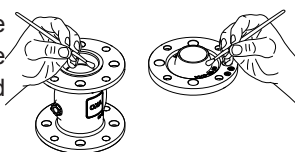

Push one flange diagonally into the sleeve and fix it in a mounting screw hole with a screw, washer and nut. Turn the nut approximately the length of a nut.

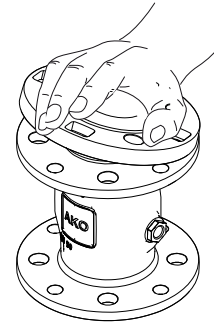

If necessary, lubricate the screws with suitable grease before screwing them in.

Push the flange opposite the fixing screw into the sleeve and tighten the second screw, washer and nut by the length of a nut.

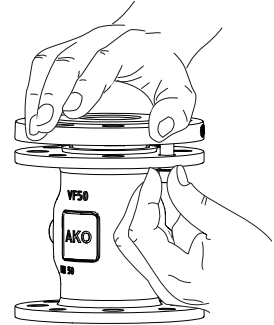

Turn the valve unit 180° and position it again.

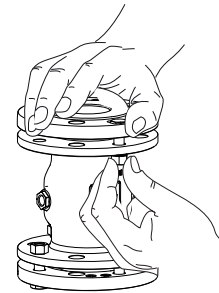

Repeat the process for the second flange.

Now tighten the screws alternately and crossways on both sides to max. 30 Nm until the flanges rest on the body.

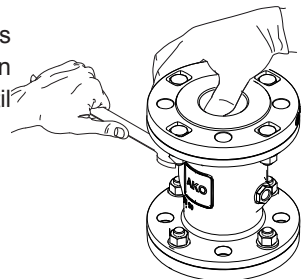

Check the function of the pinch valve by closing the pinch valve with minimal control pressure. Make sure that it closes correctly to form a lip shape.

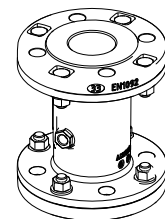

<http://www.pinch-valves.com/technical-help/vf-pinch-valve-re-sleeve/>

## 11.4 Air operated Pinch Valve series VF, DN100-300

**Assembly aids:** Assembly kit incl. assembly paste MP200 or MPL200 for the food sector, AKO assembly pipe, AKO assembly board, screws for pre-assembly

### Dismantling

Place the pinch valve facing upwards and hold it tightly on the body. Loosen the screws crossways with a spanner (SW19).

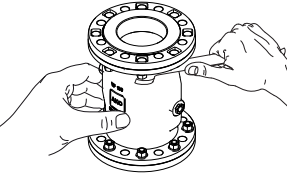

Then turn the pinch valve and also loosen all screws crossways.

Now lift both flanges off the valve unit. Use a slot screwdriver to do this if necessary.

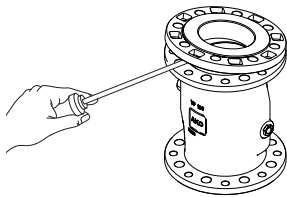

Use AKO assembly paste (MP200/MPL200) as lubrication between the body and sleeve.

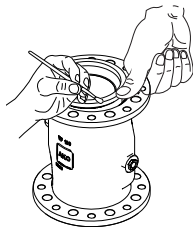

Push or pull the sleeve out of the body. Use a pipe wrench or another suitable tool if necessary.

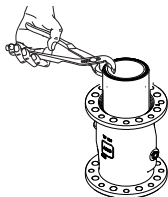

Clean all individual parts afterwards and check the parts for damage as well as for ageing and porosity. Replace damaged parts.

### Assembly

Lubricate the following parts with AKO assembly paste (MP200/MPL200):

- Inside and outside of the sleeve on both ends
- Cones of both flanges
- Inner neck of the body on both sides

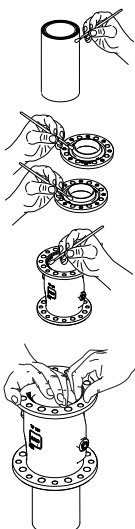

Slide or push the sleeve into the body until it protrudes evenly at both ends.

Place one flange on the sleeve, place the screws for pre-assembly into the holes and tighten the nuts with washers by hand until there is no play between the flange cone and sleeve.

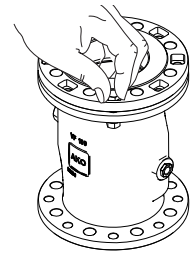

If necessary, lubricate the screws with suitable grease before screwing them in.

Turn the valve unit 180° and repeat the process with the second flange. Tighten the screws until there is slight pressure on the sleeve.

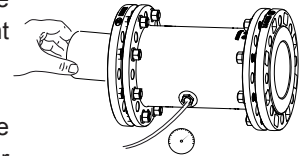

Slide the assembly pipe into the valve. Apply approx. 2 bar of air to the body via the control air connection (varies depending on the nominal size).

Push the sleeve over the flange cone using a ring spanner (SW19).

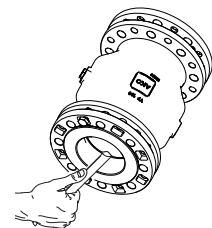

Make sure that the sleeve is protruding evenly (approx. 5-7 mm) on both sides.

Tighten the screws for pre-assembly on both sides with a spanner (SW19).

Release the control air from the body. Remove the assembly pipe. Place the mounting screws into the remaining mounting holes on each flange side and tighten them. Replace the screws for pre-assembly with mounting screws on each flange and tighten them as well.

Now tighten the screws alternately and crossways on both sides to max. 30 Nm until the flanges rest firmly on the body.

Check the function of the pinch valve.

Insert the assembly board into the valve so that the narrow side of the board is facing the air connection. Hold the assembly board firmly. Apply the minimal control pressure to the body. Make sure that it closes correctly to form a lip shape.

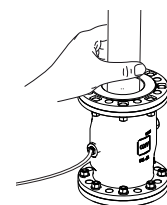

Repeat the process two or three times to give the sleeve the optimum closing direction.



<http://www.pinch-valves.com/technical-help/vf-pinch-valve-re-sleeve/>

## 11.5 Air operated Pinch Valve series VMC, DN10-50, type F, FA, G, M, N, R, RA, T, TA

**Assembly aid:** AKO assembly paste MP200 or MPL200 for the food sector

### Dismantling

Place the pinch valve facing upwards and hold it tightly on the body. Loosen the screws crossways with a ratchet or spanner (T30 Torx bit or SW10 Allen key).

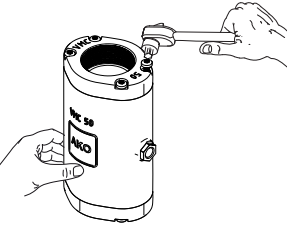

Then turn the pinch valve and also loosen all screws crossways.

Lift both the socket end cover and flange off the valve unit. Use a slot screwdriver to do this if necessary.



Push or pull the sleeve out of the body. Use a pipe wrench if necessary.

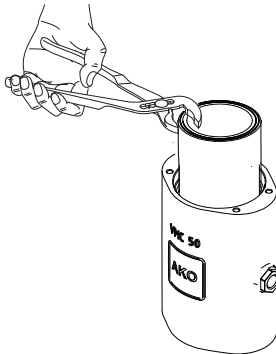

This is made easier by using AKO assembly paste (MP200/MPL200) as lubrication between the sleeve and body.

Clean all individual parts afterwards and check the parts for damage as well as for ageing and porosity. Replace damaged parts.

### Assembly

Slide the sleeve into the body until the bottom edge is sitting flush and the sleeve is protruding upwards by approx. 3-7 mm.



Use a little AKO assembly paste (MP200/MPL200) between the sleeve and body in case of stiffness.

Apply AKO assembly paste (MP200/MPL200) to the inside of both ends of the sleeve and to the cone of the socket end cover/flange.

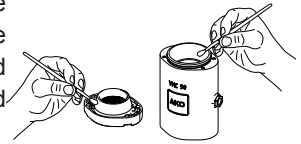

Position the valve unit with one hand and hold it firmly. Insert the socket end cover/flange diagonally into the sleeve with your other hand and push in the socket end cover/flange.



Align the socket end cover/flange with the screw holes flush with the holes in the body. Insert the screws into the designated holes.



With type M, insert the screws into the socket end cover/flange before fitting it.

If necessary, lubricate the screws with suitable grease before screwing them in.

Push and hold the socket end cover/flange and tighten the screws crossways with a ratchet or spanner until the socket end cover/flange are sitting on the body. Check all screws have an adequate tightening torque (max. 6 Nm).



Turn the valve unit 180° and position it again.

Repeat the process for the second socket end cover/flange.



Check the function of the pinch valve by closing the pinch valve with minimal control pressure. Make sure that it closes correctly to form a lip shape.



<http://www.pinch-valves.com/technical-help/vmc-pinch-valve-re-sleeve/>

## 11.6 Air operated pinch valves series VMC, DN65-80, Type F, FA

**Assembly aids:** AKO assembly paste MP200 or MPL200 for the food sector, if necessary 4 no. M10x30 ISO 4017 screws for pre-assembly

### Dismantling

Place the pinch valve facing upwards and hold it tightly on the body. Loosen the screws crossways with a spanner (SW16).

Then turn the pinch valve and also loosen all screws crossways.

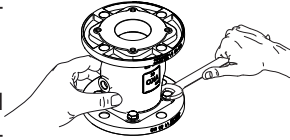

Apply AKO assembly paste (MP200/MPL200) to the inside of both ends of the sleeve and to the flange cone.

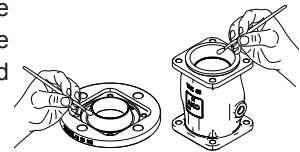

Place the flange onto a stable surface with the sealing surface facing downwards and the cone facing upwards. Take the body with the inserted sleeve and position the 5-6 mm protruding sleeve end diagonally on the flange cone. Push the body with the sleeve firmly over the cone.

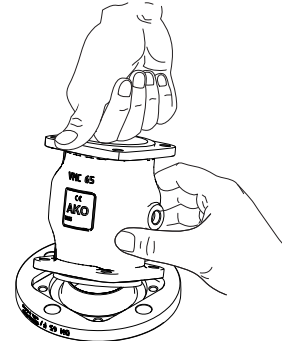

Lift both flanges off the valve unit. Use a slot screwdriver to do this if necessary.

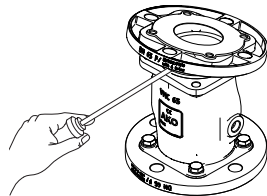

If necessary, lubricate the screws with suitable grease before screwing them in.

Align the body with the through holes with the threaded flange holes.

Push or pull the sleeve out of the body. Use a pipe wrench if necessary.

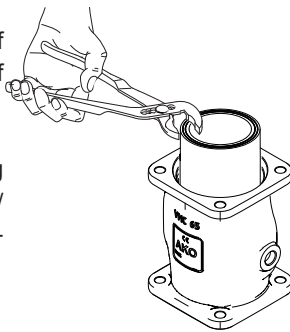

Push and hold the body, insert the screws and tighten them crossways with a spanner until the screws are sitting in the threaded flange holes.

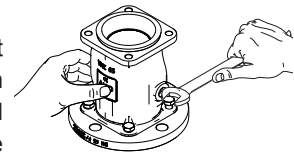

This is made easier by using AKO assembly paste (MP200/MPL200) as lubrication between the sleeve and body.

Clean all individual parts afterwards and check the parts for damage as well as for ageing and porosity. Replace damaged parts.

Turn the valve unit 180° and position it again.

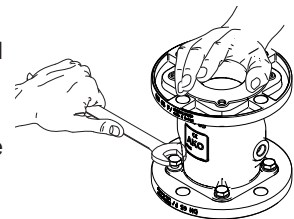

Repeat the process with the second flange.

Check all screws have an adequate tightening torque (max. 20 Nm).

### Assembly

Slide the sleeve into the body until the bottom edge is sitting flush and the sleeve is protruding upwards by approx. 5-6 mm.

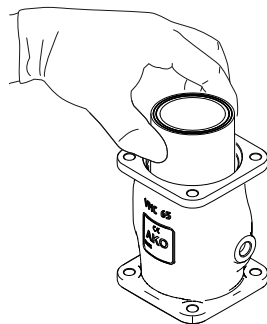

Use a little AKO assembly paste (MP200/MPL200) between the sleeve and body in case of stiffness.

Check the function of the pinch valve by closing the pinch valve with minimal control pressure. Make sure that it closes correctly to form a lip shape.

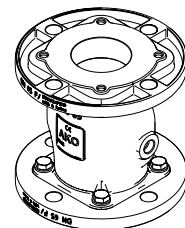

<http://www.pinch-valves.com/technical-help/vmc-pinch-valve-re-sleeve/>

## 11.7 Air operated pinch valves series VMC, DN65-80, Type G, M, N, R, RA, T, TA, FT

**Assembly aids:** AKO assembly paste MP200 or MPL200 for the food sector, if necessary 4 no. M10x45 ISO 4017 screws for pre-assembly (FT=DIN912)

### Dismantling

Place the pinch valve facing upwards and hold it tightly on the body. Loosen the screws and nuts crossways with a spanner (SW16 + FT=hexagon socket wrench 8).

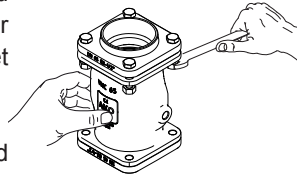

Then turn the pinch valve and also loosen all screws crossways.

Lift both covers off the valve unit. Use a slot screwdriver to do this if necessary.

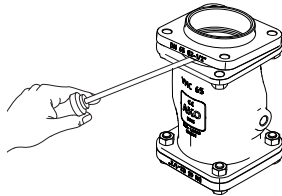

Push or pull the sleeve out of the body. Use a pipe wrench if necessary.

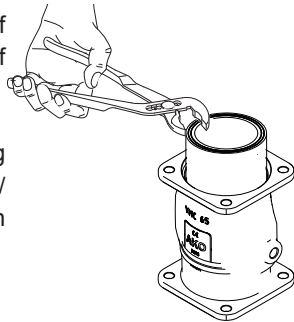

This is made easier by using AKO assembly paste (MP200/MPL200) as lubrication between the sleeve and body.

Clean all individual parts afterwards and check the parts for damage as well as for ageing and porosity. Replace damaged parts.

### Assembly

Slide the sleeve into the body until the bottom edge is sitting flush and the sleeve is protruding upwards by approx. 5-6 mm.

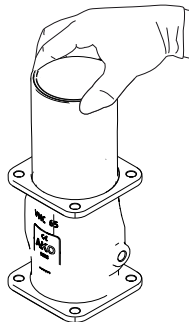

Use a little AKO assembly paste (MP200/MPL200) between the sleeve and body in case of stiffness.

Apply AKO assembly paste (MP200/MPL200) to the inside of both ends of the sleeve and to the cover cone.

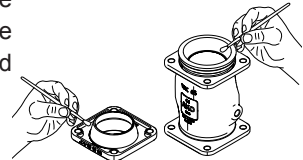

Place the valve unit so that the protruding sleeve end is at the top. Push one cover diagonally into the sleeve and fix it in a screw hole with a screw for pre-assembly, washer and nut. Turn the nut approximately the length of a nut.

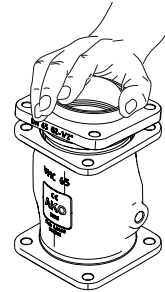

If necessary, lubricate the screws with suitable grease before screwing them in.

Align the cover with the screw holes flush with the holes in the body and push the cover into the sleeve. Insert the screws with washer and nut into the designated holes.

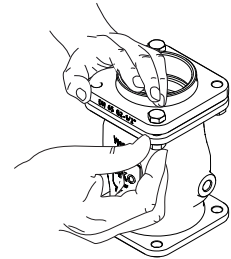

Push and hold the cover and tighten the screws and nuts crossways with a spanner (SW16 + FT=hexagon socket wrench 8) until the cover is sitting on the body.

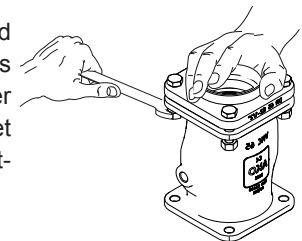

Turn the valve unit 180°.

Repeat the process for the second cover.

Check all screws have an adequate tightening torque (max. 20 Nm).

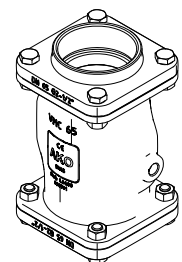

Check the function of the pinch valve by closing the pinch valve with minimal control pressure. Make sure that it closes correctly to form a lip shape.



<http://www.pinch-valves.com/technical-help/vmc-pinch-valve-re-sleeve/>



## 11.8 Air operated pinch valves series VMC, DN100, Type F, FA

**Assembly aids:** Assembly kit incl. assembly paste MP200 or MPL200 for the food sector, AKO assembly pipe, AKO assembly board, screws for pre-assembly

### Dismantling

Place the pinch valve facing upwards and hold it tightly on the body. Loosen the screws crossways with a spanner (SW19).

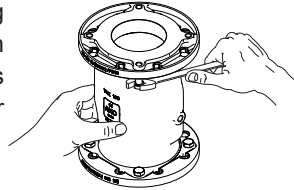

Then turn the pinch valve and also loosen all screws crossways.

Lift both flanges off the valve unit. Use a slot screwdriver to do this if necessary.

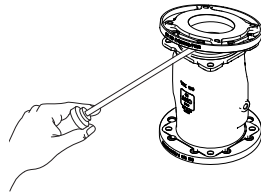

Use your thumb to push the old sleeve out of the body. Use AKO assembly paste (MP200/MLP200) as lubrication between the body and sleeve.

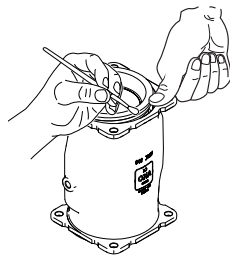

Remove the old sleeve with a pipe wrench or another suitable tool.

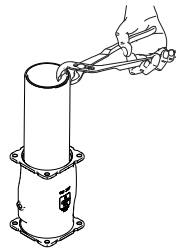

Clean all individual parts afterwards and check the parts for damage as well as for ageing and porosity. Replace damaged parts.

### Assembly

Lubricate the following parts with AKO assembly paste (MP200/MPL200):

- Inside and outside of the sleeve on both ends
- Cones of both flanges
- Inner neck of the body on both sides

Slide or push the sleeve into the body and centre the sleeve until it protrudes evenly at both ends.

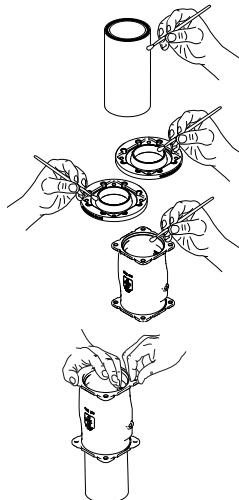

Place the flange onto a stable surface with the sealing surface facing downwards and the cone facing upwards. Take the body with the inserted sleeve and position the evenly protruding sleeve end diagonally on the flange cone. Push the body with the sleeve firmly over the cone.

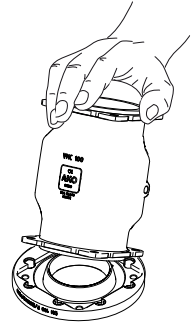

If necessary, lubricate the screws with suitable grease before screwing them in.

Insert the second screw for pre-assembly diagonally and tighten it slightly.

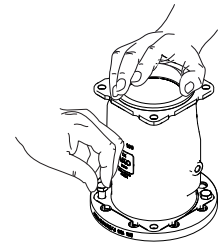

Turn the valve unit 180° and repeat the described process for the second flange.

Insert the assembly pipe into the centre of the valve. Apply approx. 2 bar of air to the body via the control air connection.

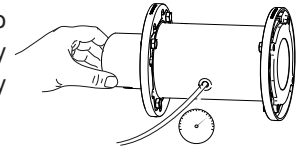

Make sure that the sleeve is protruding evenly on both sides. Tighten the screws for pre-assembly with a spanner.

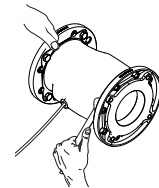

Release the control air from the body. Remove the assembly pipe. Place two mounting screws per flange side into the other two holes and tighten them. Replace the screws for pre-assembly with mounting screws on each flange.

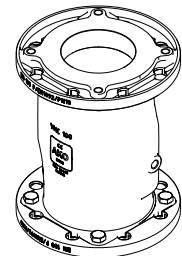

Now tighten the screws alternately and crossways on both sides to max. 30 Nm until the flanges rest on the body. Check the function of the pinch valve by closing the pinch valve with minimal control pressure. Make sure that it closes correctly to form a lip shape.

If there is a triangular closing pattern, correct this using an assembly board. Position the assembly board with the narrow side in alignment with the control air connection and hold it tightly.

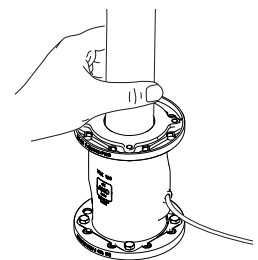

<http://www.pinch-valves.com/technical-help/vmc-pinch-valve-re-sleeve/>



## 11.9 Air operated pinch valves series VMC, DN 100, Type G, M, R, RA, T, A

**Assembly aids:** Assembly kit incl. assembly paste MP200 or MPL200 for the food sector, AKO assembly pipe, AKO assembly board, screws for pre-assembly

### Dismantling

Place the pinch valve facing upwards and hold it tightly on the body. Loosen the screws and nuts crossways with a spanner (hexagon SW19).

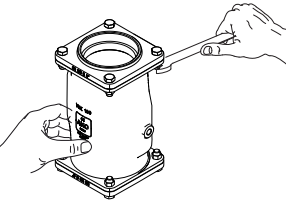

Then turn the pinch valve and also loosen all screws crossways.

Lift both covers off the valve unit. Use a slot screwdriver to do this if necessary.

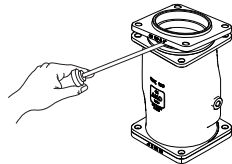

Use your thumb to push the old sleeve out of the body. Use AKO assembly paste (MP200/MPL200) as lubrication between the body and sleeve.



Remove the old sleeve with a pipe wrench or another suitable tool.



Clean all individual parts afterwards and check the parts for damage as well as for ageing and porosity. Replace damaged parts.

### Assembly

Lubricate the following parts with AKO assembly paste (MP200/MPL200):

- Inside and outside of the sleeve on both ends
- Cones of both covers
- Inner neck of the body on both sides

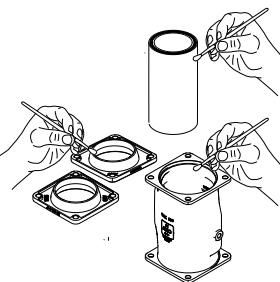

Slide or push the sleeve into the body and centre the sleeve until it protrudes evenly at both ends.

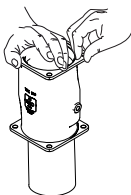

Place the valve unit onto a stable surface. Push one cover diagonally into the sleeve and fix it in a screw hole with a screw for pre-assembly, washer and nut. Turn the nut approximately the length of a nut.

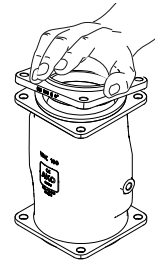

If necessary, lubricate the screws with suitable grease before screwing them in.

Insert the second screw for pre-assembly diagonally and tighten it slightly.

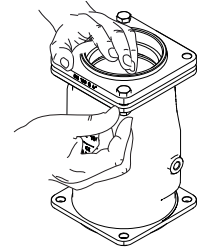

Turn the valve unit 180° and repeat the process with the second cover.

Insert the assembly pipe into the centre of the valve. Apply approx. 2 bar of air to the body via the control air connection.

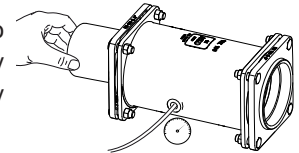

Tighten the mounting screws of both socket end covers.

Make sure that the sleeve is protruding evenly on both sides. Tighten the screws for pre-assembly with a spanner.

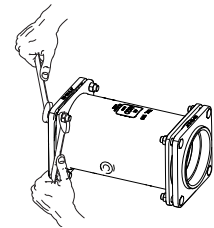

Release the control air from the body. Remove the assembly pipe. Insert two mounting screws per cover and tighten them.

Replace the screws for pre-assembly on both covers with mounting screws and tighten them.

Now tighten the screws alternately and crossways on both sides to max. 30 Nm until the covers rest on the body.

Check the function of the pinch valve by closing the pinch valve with minimal control pressure. Make sure that it closes correctly to form a lip shape.

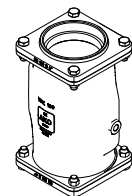

If there is a triangular closing pattern, correct this using an assembly board. Position the assembly board with the narrow side in alignment with the control air connection and hold it tightly.

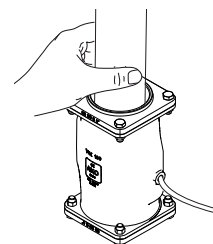

<http://www.pinch-valves.com/technical-help/vmc-pinch-valve-re-sleeve/>

## 11.10 Air operated pinch valves series VMC, DN125-150, Type F, FA, R, RA, T, TA

**Assembly aids:** Assembly kit incl. assembly paste MP200 or MPL200 for the food sector, AKO assembly pipe, AKO assembly board, screws for pre-assembly

### Dismantling

Place the pinch valve facing upwards and hold it tightly on the body. Loosen the screws crossways with a spanner (SW19).

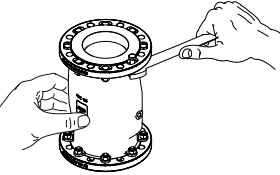

Then turn the pinch valve and also loosen all screws crossways.

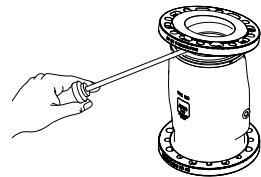

Now lift both flanges/socket end covers off the valve unit. Use a slot screwdriver to do this if necessary.



Use your thumb to push the old sleeve out of the body. Use AKO assembly paste (MP200/MLP200) as lubrication between the body and sleeve

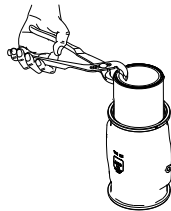

Remove the old sleeve with a pipe wrench or another suitable tool.

Clean all individual parts afterwards and check the parts for damage as well as for ageing and porosity. Replace damaged parts.

### Assembly

Lubricate the following parts with AKO assembly paste (MP200/MPL200):

- Inner neck of the body
- Inside and outside of the sleeve on both ends
- Cones of both flanges/socket end covers

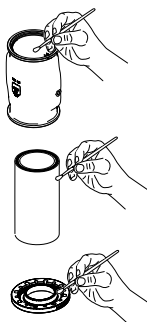

Slide or push the sleeve into the body until it protrudes evenly at both ends.



Push one flange/socket end cover diagonally into the sleeve and fix it in a screw hole with a screw for pre-assembly, mounting disc (area to the body) and nut. Turn the nut approximately the length of a nut.



If necessary, lubricate the screws with suitable grease before screwing them in.

Align the groove in the flange/socket end cover with the screw on the body. Push the flange/socket end cover into the sleeve. Insert the second screw for pre-assembly diagonally and tighten it approximately the length of a nut.



Insert two further mounting screws twisted at 90°, as described above. Turn the valve unit 180° and repeat the process with the second flange/socket end cover.

Slide the assembly pipe into the valve. Apply approx. 2 bar of air to the body via the control air connection (varies depending on the nominal size).

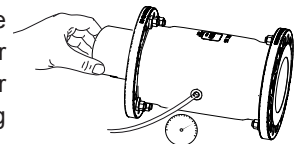

Make sure that the sleeve is protruding evenly (approx. 5-8 mm) on both sides.



Tighten the screws for pre-assembly on both sides with a spanner (SW19).

Release the control air from the body. Remove the assembly pipe. Place the mounting screws into the remaining mounting holes on each flange side/socket end cover side and tighten them. Replace the screws for pre-assembly with mounting screws on each flange/socket end cover and tighten them as well.

Now tighten the screws alternately and crossways on both sides to max. 30 Nm until the flanges rest firmly on the body.

Check the function of the pinch valve.

Insert the assembly board into the valve so that the narrow side of the board is facing the air connection. Hold the assembly board firmly. Apply the minimal control pressure to the body. Make sure that it closes correctly to form a lip shape.

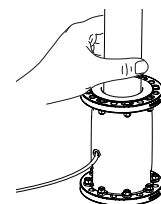

Repeat the process two or three times to give the sleeve the optimum closing direction.

## 11.11 Air operated pinch valves series VMP, DN10-50

**Assembly aid:** AKO assembly paste MP200 or MPL200 for the food sector

### Dismantling

Place the pinch valve facing upwards and hold it tightly on the body. Loosen the screws crossways with a ratchet (T30 Torx bit).

Then turn the pinch valve and also loosen all screws crossways.

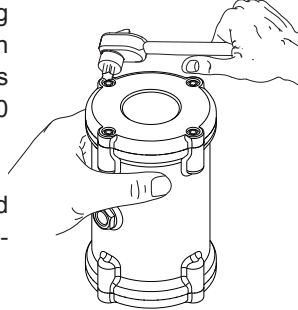

Lift both socket end covers off the valve unit. Use a slot screwdriver to do this if necessary.

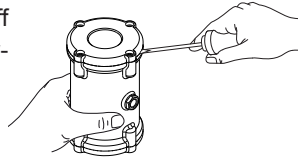

Push or pull the sleeve through the pressure zone rings out of the body.

This is made easier by using AKO assembly paste (MP200/MPL200) as lubrication between the sleeve and pressure zone ring.

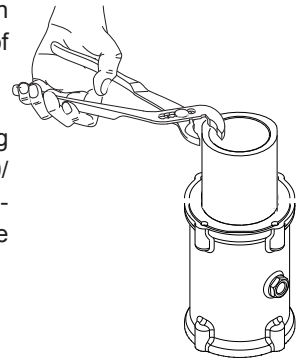

Clean all individual parts afterwards and check the parts for damage as well as for ageing and porosity. Replace damaged parts.

Replace the body following two assemblies to ensure the thread strength.

### Assembly

Pull the sealing ring over the pressure zone ring and push it into the designated groove.

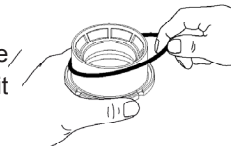

Repeat the process for the second pressure zone ring.

Slide both pressure zone rings including the sealing ring into the body.

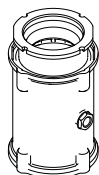

Apply a thin layer of AKO assembly paste (MP200/MPL200) to the outside of one end of the sleeve.

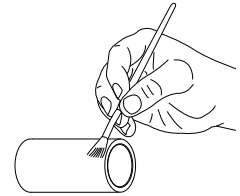

Slide the coated end of the sleeve through the first pressure zone ring into the body until the sleeve through the second pressure zone ring is flush with the bottom edge of the body.

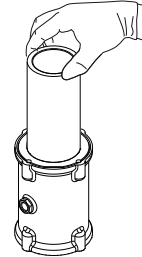

Apply enough AKO assembly paste (MP200/MPL200) to both ends of the sleeve and to the cone of the socket end cover.

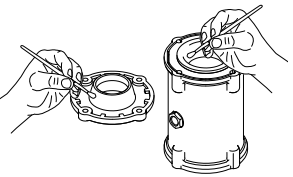

Position the valve unit with one hand and hold it firmly. Insert the socket end cover diagonally into the sleeve with your other hand and push in the socket end cover.

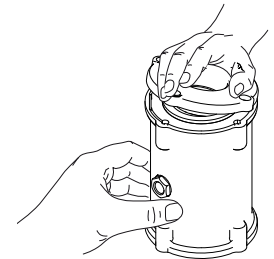

Align the socket end cover with the screw holes flush with the holes in the body. Insert the screws into the designated holes.

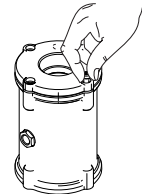

Push and hold the socket end cover and tighten the screws crossways with a ratchet until the socket end cover is sitting on the body. Check all screws have an adequate tightening torque (max. 4 Nm).

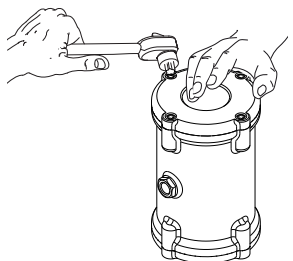

Turn the valve unit 180° and position it again.

Repeat the process for the second socket end cover.

Check the function of the pinch valve by closing the pinch valve with minimal control pressure. Make sure that it closes correctly to form a lip shape.



<http://www.pinch-valves.com/technical-help/vmp-pinch-valve-re-sleeve/>

## 11.12 Air operated pinch valves series VM+VMF, DN10-50

**Assembly aid:** AKO assembly paste MP200 or MPL200 for the food sector

### Dismantling

Clamp the complete valve in a vice and remove both coupling nuts by hand. Loosen the vice and remove both socket ends.

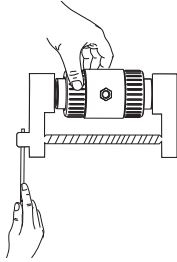

Push or pull the sleeve out of the body. Use a pipe wrench if necessary.

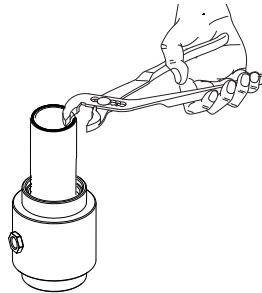

This is made easier by using AKO assembly paste (MP200/MPL200) as lubrication between the sleeve and body.

Clean all individual parts afterwards and check the parts for damage as well as for ageing and porosity. Replace damaged parts.

### Assembly

Insert the sleeve into the body until it protrudes evenly at both ends.

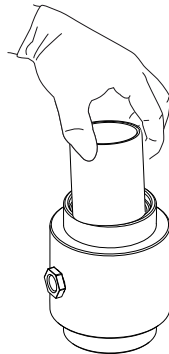

This is made easier by using AKO assembly paste (MP200/MPL200) as lubrication between the sleeve and body.

Note: Lubricate the thread on the body with suitable grease with valve bodies made of aluminium or stainless steel.

Apply AKO assembly paste (MP200/MPL200) to the inside of both ends of the sleeve and to the cone of the socket ends.

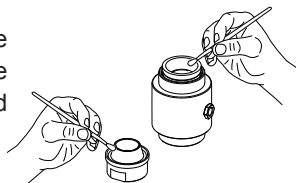

Place the body with the sleeve in a vertical position and hold it tightly with one hand. Push the cone of the socket end into the sleeve with your other hand.

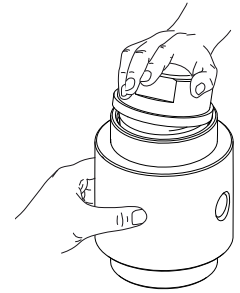

Push and hold the socket end with one hand whilst placing the coupling nut onto the socket end with your other hand. Reach through to push and hold the socket end. Now push the socket end with one hand and turn the coupling nut onto the thread of the valve with your other hand.

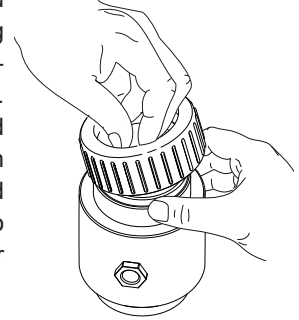

Turn the valve 180° and proceed as described to fit the second socket end using the coupling nut.

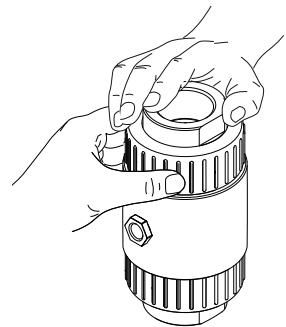

Clamp the valve unit with the socket ends horizontally in a vice. Turn the vice inwards until the socket ends rest on the body. Now tighten both coupling nuts by hand. Do not use a tool to tighten them.

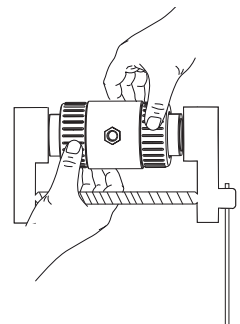

Check the function of the pinch valve by closing the pinch valve with minimal control pressure. Make sure that it closes correctly to form a lip shape.

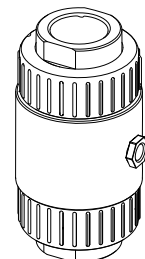



### 11.13 Air operated pinch valves series VT, DN100

**Assembly aids:** Assembly kit incl. assembly paste MP200 or MPL200 for the food sector, AKO assembly pipe, AKO assembly board, screws (M10x60 DIN912) for pre-assembly.

#### Dismantling

Place the pinch valve facing upwards and hold it tightly on the body. Loosen the screws crossways with a spanner (SW17) and hexagon socket wrench (8).

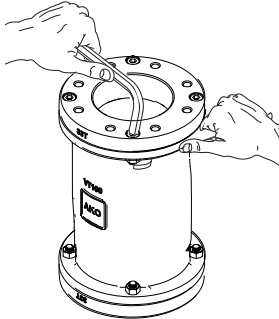

Then turn the pinch valve and also loosen all screws crossways.

Now lift both flanges off the valve unit. Use a slot screwdriver to do this if necessary.

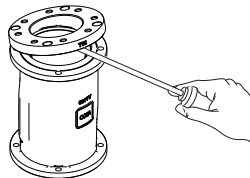

Use your thumb to push the old sleeve out of the body. Use AKO assembly paste (MP200/MLP200) as lubrication between the body and sleeve.



Remove the old sleeve with a pipe wrench or another suitable tool.

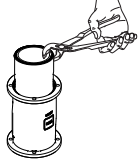

Clean all individual parts afterwards and check the parts for damage as well as for ageing and porosity. Replace damaged parts.

#### Assembly

Lubricate the following parts with AKO assembly paste (MP200/MPL200):

- Inside and outside of the sleeve on both ends
- Cones of both flanges
- Inner neck of the body on both sides

Slide or push the sleeve into the body until it protrudes evenly at both ends.

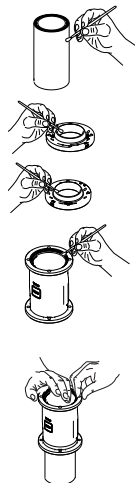

Push one flange diagonally into the sleeve and fix it in a screw hole with a screw for pre-assembly, washer and nut. Turn the nut approximately the length of a nut.

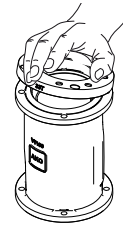

If necessary, lubricate the screws with suitable grease before screwing them in.

Push the flange into the sleeve. Insert the second screw for pre-assembly diagonally and tighten it approximately the length of a nut.



Turn the valve unit 180° and repeat the process with the second flange.

Slide the assembly pipe into the valve. Apply approx. 2 bar of air to the body via the control air connection. Make sure that the sleeve is protruding evenly on both sides. Tighten the screws for pre-assembly with a spanner (SW17) and hexagon socket wrench (8).

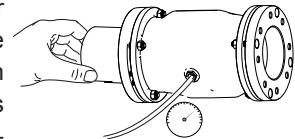

Release the control air from the body. Remove the assembly pipe. Place two mounting screws per flange side into the other two holes and tighten them. Replace the screws for pre-assembly with mounting screws on each flange.

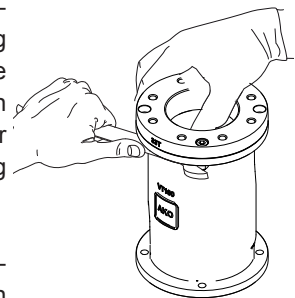

Now tighten the screws alternately and crossways on both sides to max. 20 Nm until the flanges rest firmly on the body.

Check the function of the pinch valve by closing the pinch valve with minimal control pressure. Make sure that it closes correctly to form a lip shape.

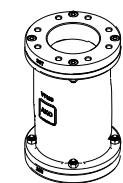

If there is a triangular closing pattern, correct this using an assembly board. Position the assembly board with the narrow side in alignment with the control air connection and hold it tightly.

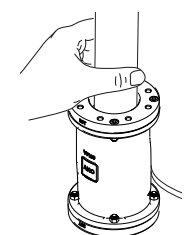

<http://www.pinch-valves.com/technical-help/vid-eos/>

## 12. Appendix

### Possible malfunctions of air-operated pinch valves

MALFUNCTION	POSSIBLE CAUSE	SOLUTION
Pinch valve does not close or not fully close	- No control air present	- Check compressed air lines - Check if control pressure is present on pinch valve
	- Control valve defective	- Check/replace control valve
	- Control pressure too low	- Check ideal control pressure to be set
	- Sleeve defective	- Replace sleeve
	- Sleeve does not close in lip shape	- Correct closing pattern of sleeve using the assembly board
Pinch valve does not open or not fully open	- Bleed bore on control valve clogged	- Clean silencer/control air line
	- Vacuum in the pumping area	- Vacuum compensator (e.g.. AKOVAC)
	- Pinch valve connected for extended period	- Vacuum-supported opening (e.g.. AKOVAC)
	- Control valve defective (does not switch)	- Check/replace control valve
Sleeve wears out quickly	- Excessive control pressure/differential pressure	- Check ideal control pressure to be set
	- Switching (open/closed) to fast	- Increase switching time
	- Turbulence in the feed pipe/pinch valve to close to an elbow	- Change feed pipe or arrangement of pinch valve (minimum distance to elbow)
	- Pinch valve does not fully close	- Check ideal control pressure to be set
	- Unfavourable operating conditions (e.g. excessive temperature, operating pressure or flow speed)	- Change operating conditions
	- Pinch valve opens/closes too slowly	- See malfunction "Pinch valve opens/closes too slowly"
	- Vacuum in the pumping area	- Vacuum compensator (e.g.. AKOVAC)
	- Sleeve quality not suitable for pumping medium	- Use different sleeve quality
Pinch valve opens/closes too slowly	- Control air line is too small	- Enlarge control air line as described in the Operating manual. - Install quick bleed valve
	- Control air line is too long	- Shorten control air line - Install control valve directly on pinch valve - Install quick bleed valve
	- Bleed bore on control valve clogged.	- Clean silencer/control air line
	- Control air connection too small	- Enlarge air connection or use pinch valve with two air connections
	- Outlet of control valve too small	- Install larger control valve
Control medium (e.g. air) enters the pumping area	- Sleeve defective	- Replace sleeve
Control medium exits the bleed outlet of the control valve	- Sleeve defective	- Replace sleeve